

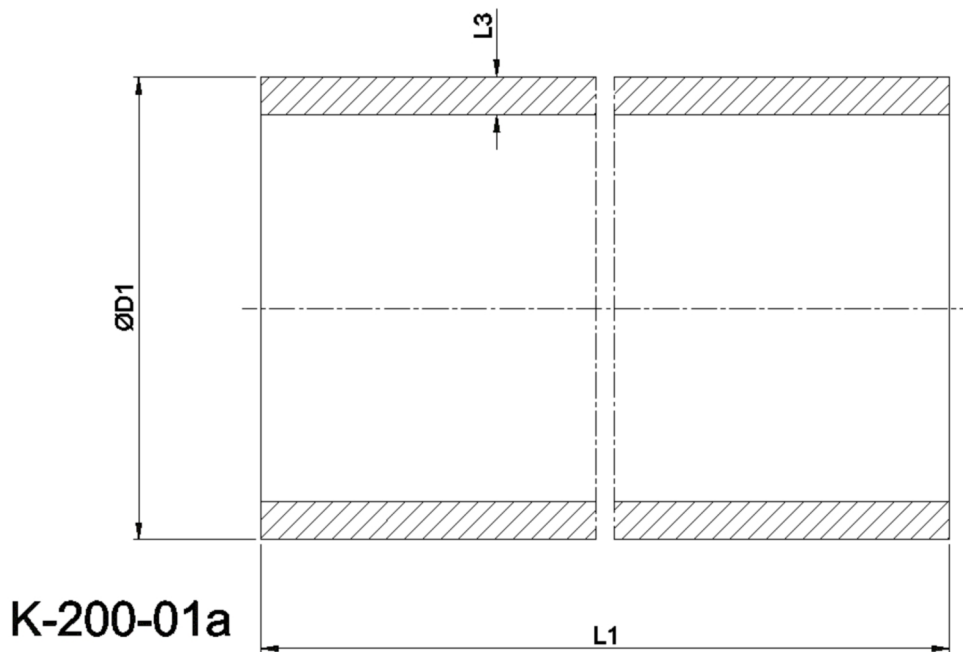

Artikelnummer identification code	<h1>25601</h1>	Fotos und Bilder dienen nur der Veranschaulichung. Abweichungen in Farbe und Form sind möglich! Photos and figures are for illustration onla. Colour and design ist not guaranteed.
Präzisionsstahlrohr - geschweißt, kaltgezogen	welded cold drawn precision steel tube	
120,00x3,00 EN10305-2 +C E355	120,00x3,00 EN10305-2 +C E355	



Gewicht: 8,656 kg

D1	120,00	L3	3,00
----	--------	----	------