

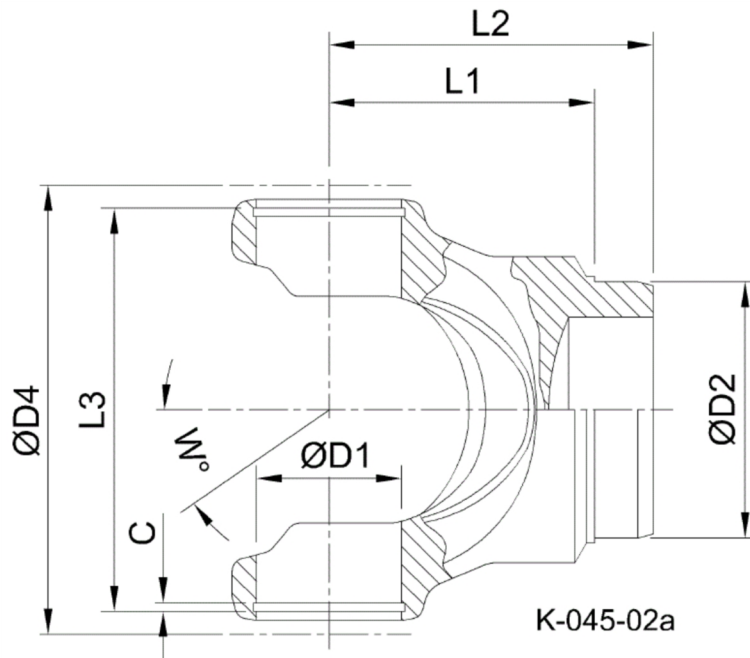

Artikelnummer identification code	<h1>0450281</h1>	Fotos und Bilder dienen nur der Veranschaulichung. Abweichungen in Farbe und Form sind möglich! Photos and figures are for illustration onla. Colour and design ist not guaranteed.
Schweisszapfen RA=36,1 / L1=32		tube yoke tc=36,1 / L1=32
für KR 17x41		for UJ 17x41



Gewicht: 0,240 kg

D1	17,00	L1	32,00	W	30°
D2	36,10				