

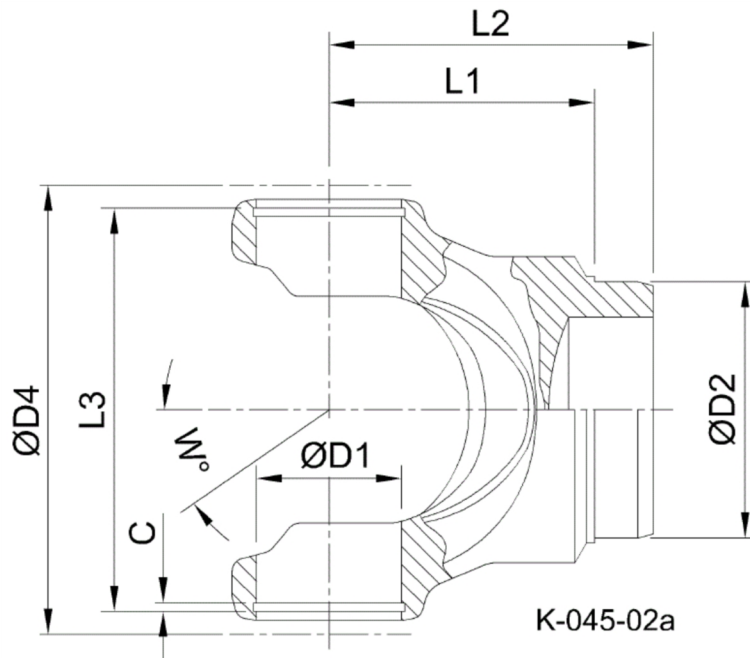

Artikelnummer identification code	<h1>0450237-1</h1>	Fotos und Bilder dienen nur der Veranschaulichung. Abweichungen in Farbe und Form sind möglich! Photos and figures are for illustration onla. Colour and design ist not guaranteed.
Schweißzapfen RA=90,3 / L1=82 für KR 48x161	tube yoke tc=90,3 / L1=82 for UJ 48x161	



Gewicht: 5,600 kg

D1	48,00	L1	82,00	W	25°
D2	90,30	L3	164,40		