

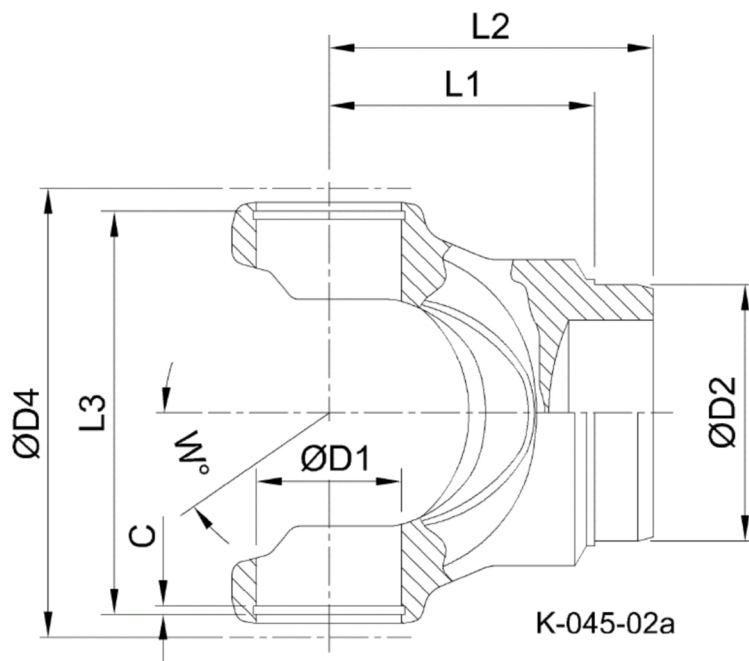

Artikelnummer identification code	<h1>0450211-1</h1>	Fotos und Bilder dienen nur der Veranschaulichung. Abweichungen in Farbe und Form sind möglich!  Photos and figures are for illustration onla. Colour and design ist not guaranteed.
Schweißzapfen RA97,3 / L1=120 für KR 57x164	tube yoke tc=97,3 / L1=120 for UJ 57x164	



Gewicht: 5,500 kg

D1	57,00	L1	120,00	W	22°
D2	97,30	L3	167,90		