

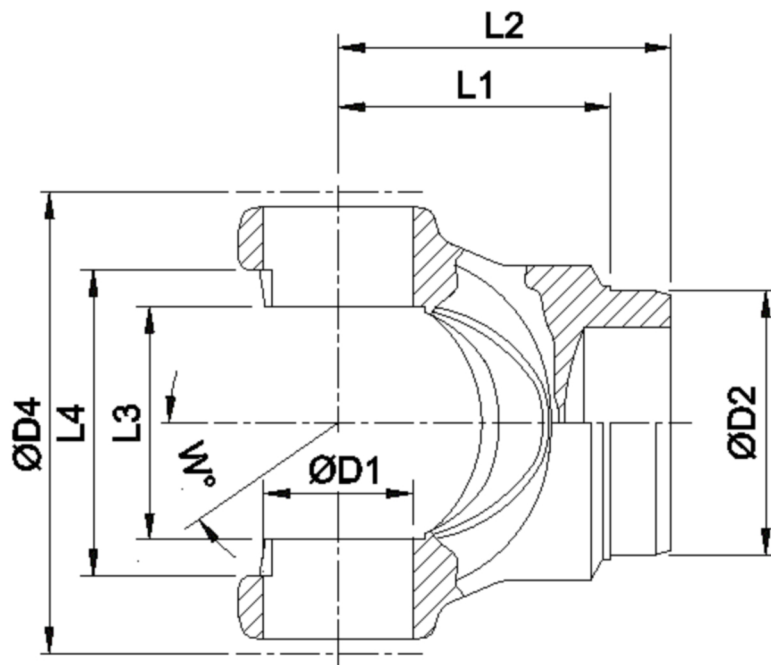

Artikelnummer identification code	<h1>0450111-5</h1>	Fotos und Bilder dienen nur der Veranschaulichung. Abweichungen in Farbe und Form sind möglich! Photos and figures are for illustration onla. Colour and design ist not guaranteed.
Schweisszapfen RA=98,5 / L1=126		tube yoke tc=98,5 / L1=126
für KR 68x89		for UJ 68x89



Gewicht: 8,000 kg

D1	68,00	L1	126,00	W	22°
D2	98,50	L3	89,00		