

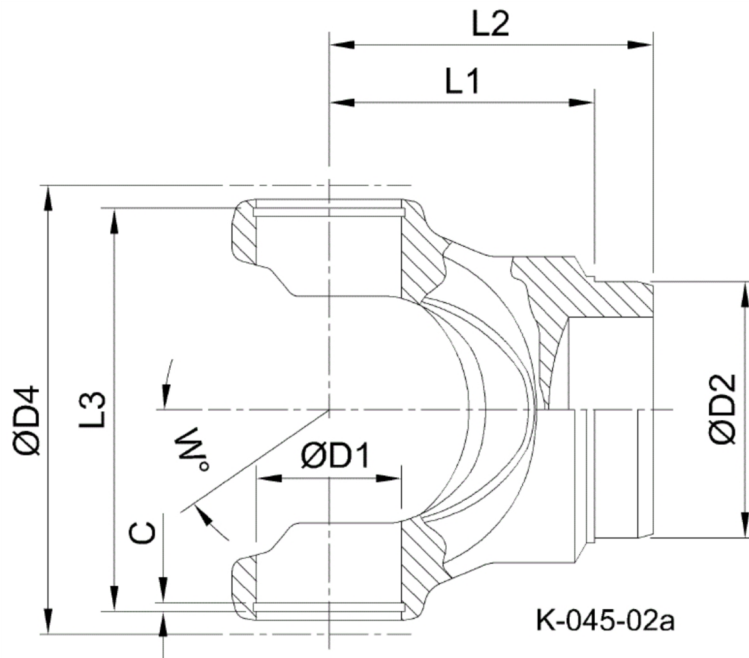

Artikelnummer identification code	<h1>0450102-2</h1>	Fotos und Bilder dienen nur der Veranschaulichung. Abweichungen in Farbe und Form sind möglich! Photos and figures are for illustration onla. Colour and design ist not guaranteed.
Schweißzapfen RA=82,4 / L1=90 für KR 57x164	tube yoke tc=82,4 / L1=90 for UJ 57x164	



Gewicht: 4,500 kg

D1	57,00	L1	90,00	W	35°
D2	82,20	L3	167,90		