

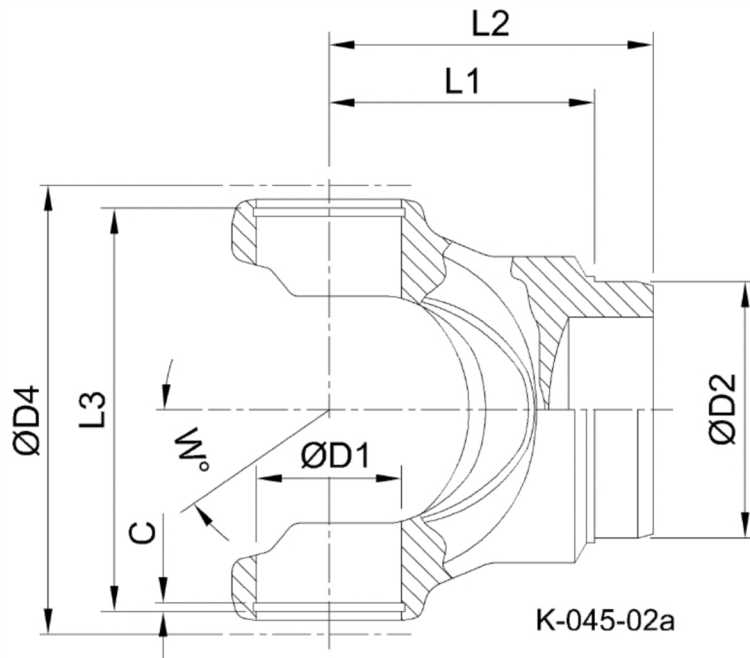

Artikelnummer identification code	<h1>0450101-2</h1>	Fotos und Bilder dienen nur der Veranschaulichung. Abweichungen in Farbe und Form sind möglich!  Photos and figures are for illustration onla. Colour and design ist not guaranteed.
Schweisszapfen RA=91,3 / L1=100		tube yoke tc=91,3 / L1=100
für KR 48x135,4		for UJ 48x135,4



Gewicht: 3,200 kg

D1	48,00	L1	100,00	W	44°
D2	91,30	L3	138,60		