

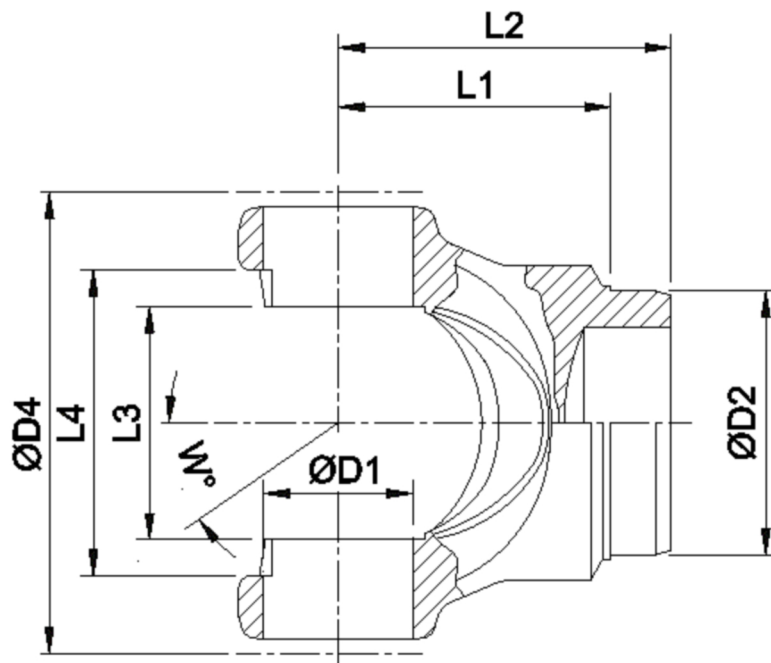

Artikelnummer identification code	0450080-6	Fotos und Bilder dienen nur der Veranschaulichung. Abweichungen in Farbe und Form sind möglich! Photos and figures are for illustration onla. Colour and design ist not guaranteed.
--------------------------------------	------------------	--

Schweisszapfen RA=130,2 / L1=145	tube yoke tc=130,2 / L1=145
----------------------------------	-----------------------------

für KR 68x89	for UJ 68x89
--------------	--------------



Gewicht: 10,000 kg

D1	68,00	L1	145,00	W	22°
D2	130,20	L3	89,00		