

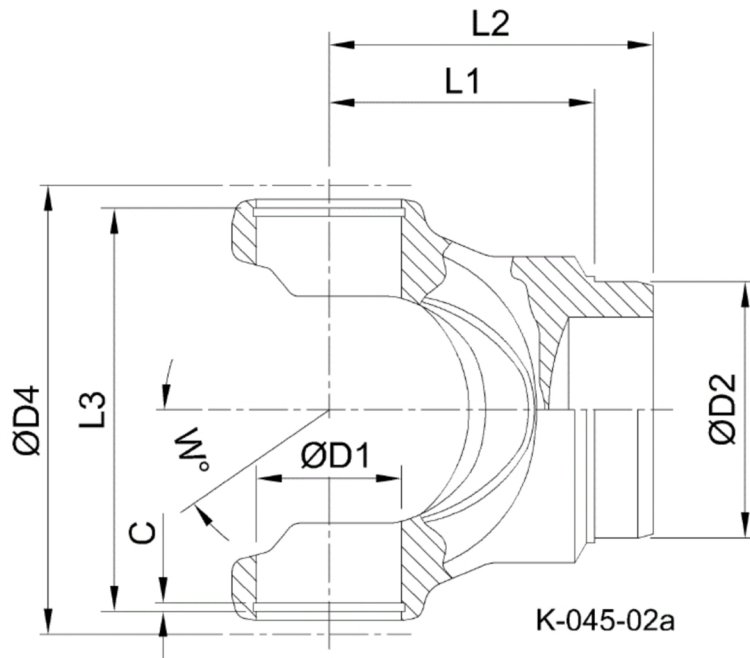

Artikelnummer identification code	<h1>0450065-1</h1>	Fotos und Bilder dienen nur der Veranschaulichung. Abweichungen in Farbe und Form sind möglich! Photos and figures are for illustration onla. Colour and design ist not guaranteed.
Schweisszapfen RA=94,2 / L1=95 für KR 38x110	tube yoke tc=94,2 / L1=95 for UJ 38x110	



Gewicht: 2,650 kg

D1	38,00	L1	111,00	W	35°
D2	94,20	L3	113,40		