

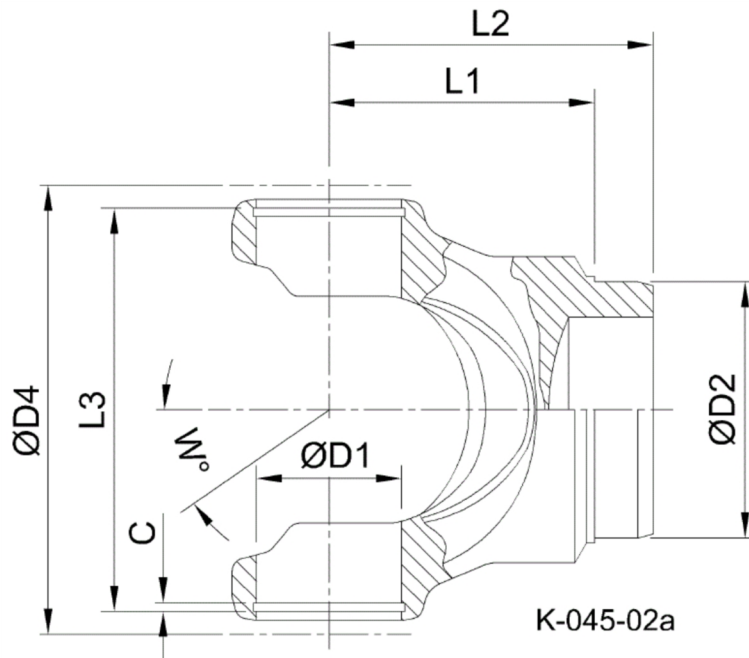

Artikelnummer identification code	<h1>0450063-4</h1>	Fotos und Bilder dienen nur der Veranschaulichung. Abweichungen in Farbe und Form sind möglich!  Photos and figures are for illustration onla. Colour and design ist not guaranteed.
Schweisszapfen RA=114,2 / L1=89 für KR 47,6x135,1	tube yoke tc=114,2 / L1=89 for UJ 47,6x135,1	



Gewicht: 4,420 kg

D1	47,60	L1	89,00	W	25°
D2	114,20	L3	138,40		