

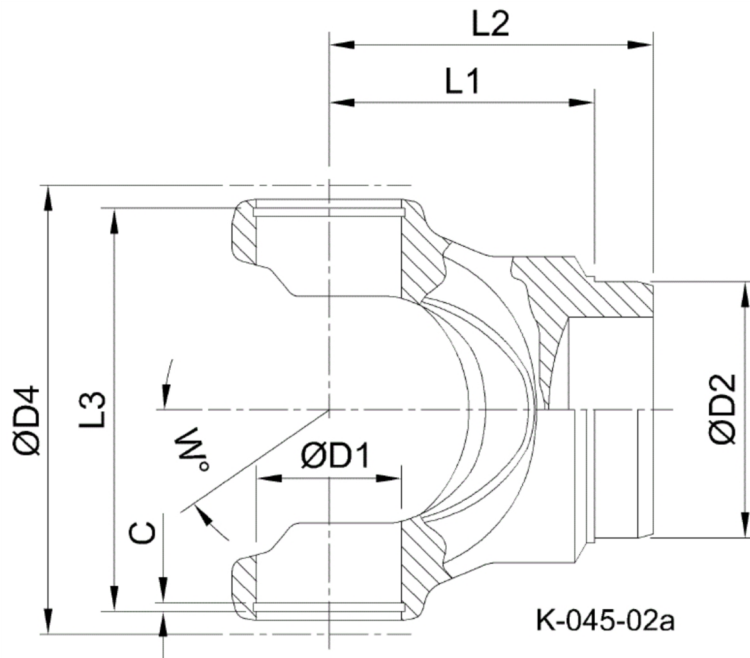

Artikelnummer identification code	<h1>0450014-1</h1>	Fotos und Bilder dienen nur der Veranschaulichung. Abweichungen in Farbe und Form sind möglich! Photos and figures are for illustration onla. Colour and design ist not guaranteed.
Schweißzapfen RA=112,4 / L1=97 für KR 52x147,2	tube yoke tc=112,4 / L1=97 for UJ 52x147,2	



Gewicht: 5,000 kg

D1	52,00	L1	97,00	W	25°
D2	112,40	L3	151,00		