

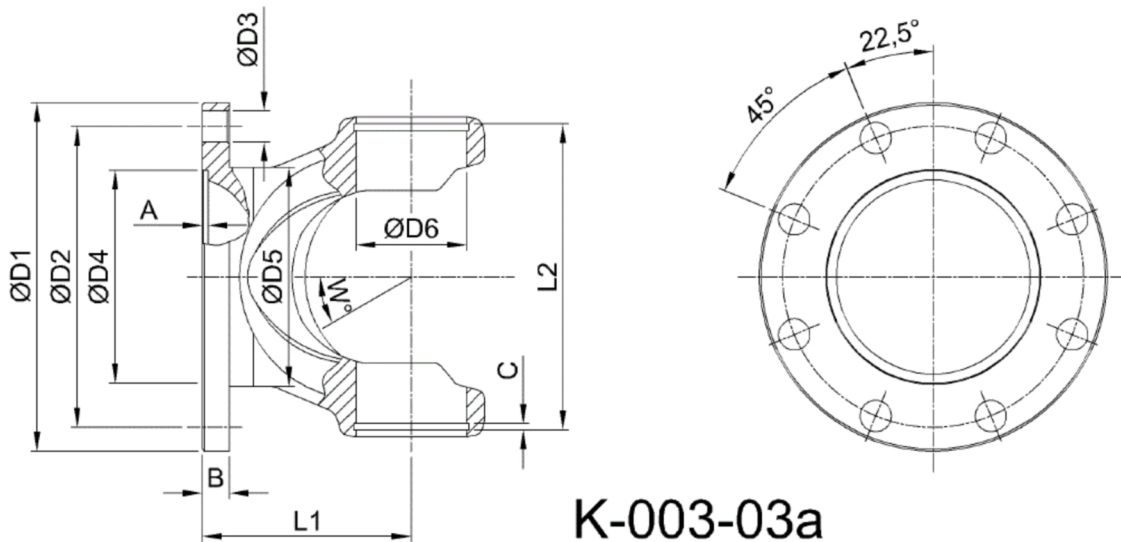

Artikelnummer identification code	<h1>0030444-3</h1>	Fotos und Bilder dienen nur der Veranschaulichung. Abweichungen in Farbe und Form sind möglich! Photos and figures are for illustration onla. Colour and design ist not guaranteed.
Gabelflansch DIN 225/8-16 / L1=108 für KR 72x185	flange yoke DIN 225/8-16 / L1=108 for UJ 72x185	



Gewicht: 10,300 kg

D1	225,00	L1	108,00	A	5,00	W	24°
D2	196,00			B	15,00		
D4	140,00						
D5	160,00						
D6	72,00						