

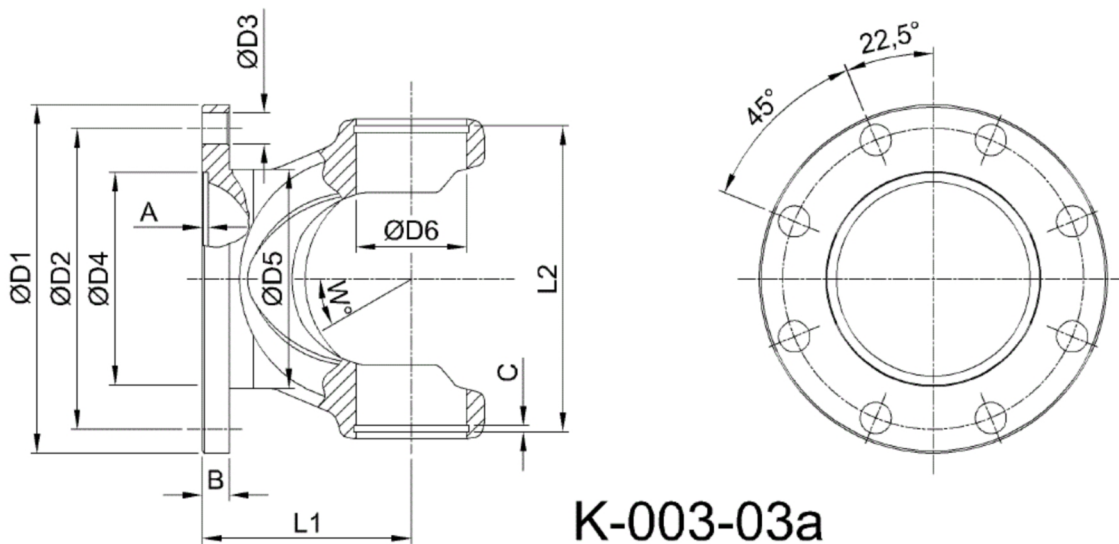

Artikelnummer identification code	<h1>0030345</h1>	Fotos und Bilder dienen nur der Veranschaulichung. Abweichungen in Farbe und Form sind möglich! Photos and figures are for illustration onla. Colour and design ist not guaranteed.
Gabelflansch DIN 150/8-10 / L1=70	flange yoke DIN 150/8-10 / L1=70	
für KR 35x96,8	for UJ 35x96,8	



K-003-03a

Gewicht: 1,970 kg

D1	150,00	L1	70,00	A	3,00	W	35°
D2	130,00	L2	100,00	B	9,00		
D3	10,00			C	2,50		
D4	90,00						
D6	35,00						