

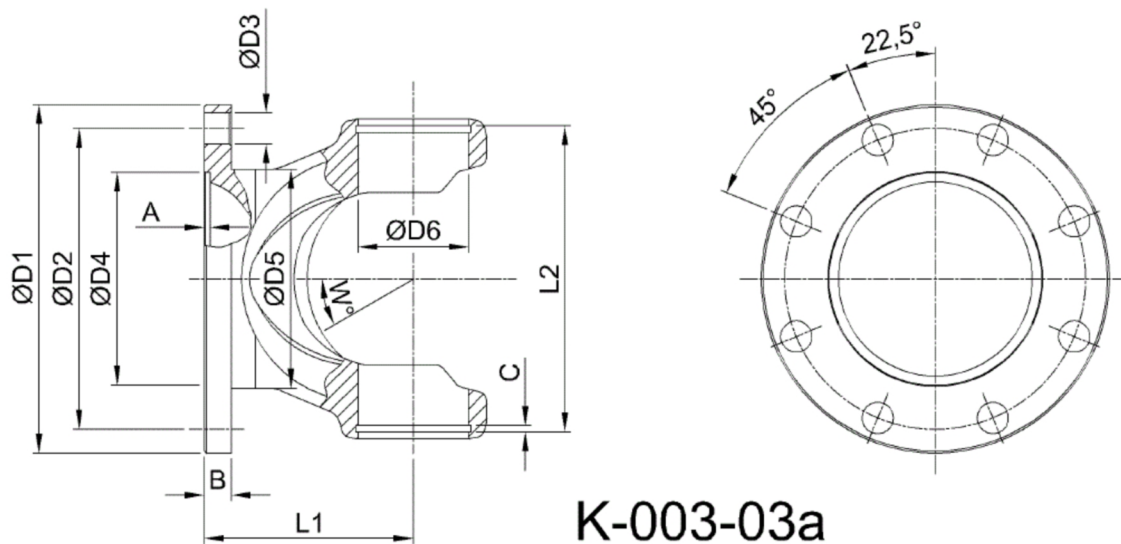

Artikelnummer identification code	<h1>0030326-2</h1>	Fotos und Bilder dienen nur der Veranschaulichung. Abweichungen in Farbe und Form sind möglich! Photos and figures are for illustration onla. Colour and design ist not guaranteed.
Gabelflansch DIN 250/8-18 / L1=110 für KR 65x172	flange yoke DIN 250/8-18 / L1=110 for UJ 65x172	



K-003-03a

Gewicht: 13,800 kg

D1	250,00	L1	110,00	A	6,00	W	25°
D2	218,00	L2	177,00	B	18,00		
D3	18,00			C	3,15		
D4	140,00						
D6	65,00						