

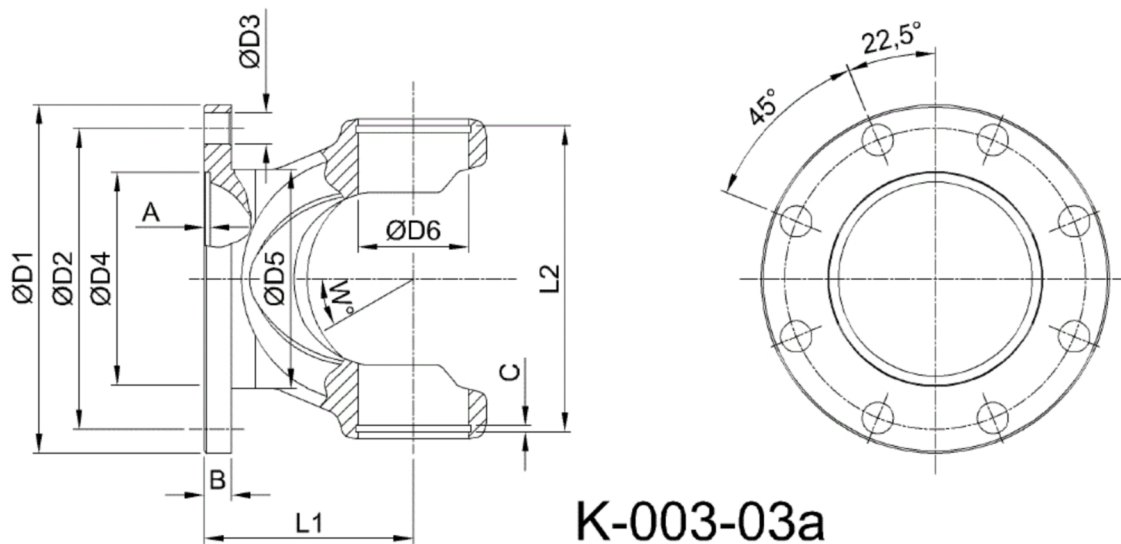

Artikelnummer identification code	<h1>0030317-1</h1>	Fotos und Bilder dienen nur der Veranschaulichung. Abweichungen in Farbe und Form sind möglich! Photos and figures are for illustration onla. Colour and design ist not guaranteed.
Gabelflansch DIN 180/8-14 / L1=95 für KR 57x152	flange yoke DIN 180/8-14 / L1=95 for UJ 57x152	



K-003-03a

Gewicht: 6,400 kg

D1	180,00	L1	95,00	A	3,00	W	25°
D2	155,50	L2	155,90	B	14,00		
D3	14,00						
D4	110,00						
D6	57,00						