

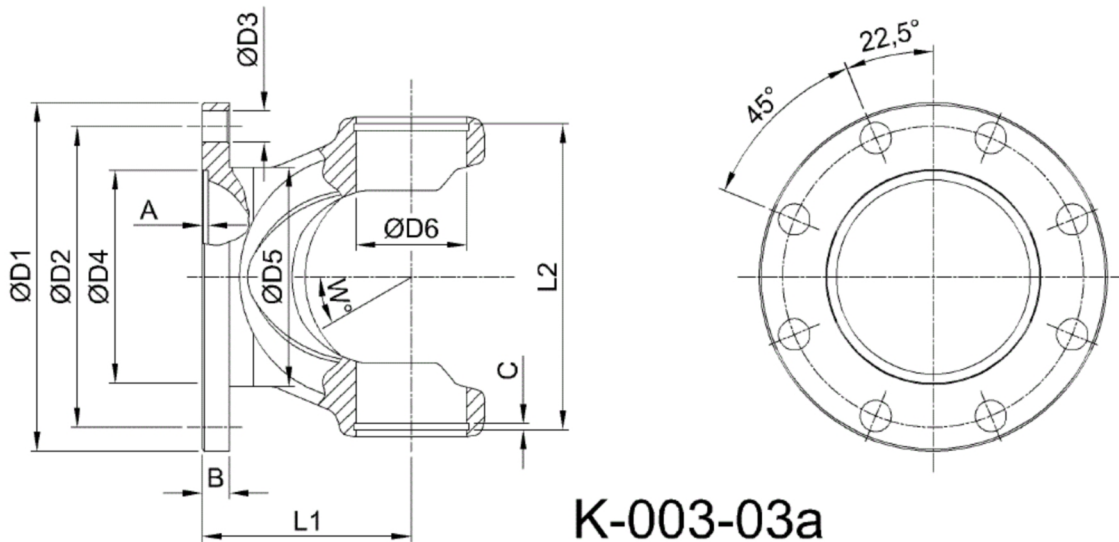

Artikelnummer identification code	<h1>0030257-2</h1>	Fotos und Bilder dienen nur der Veranschaulichung. Abweichungen in Farbe und Form sind möglich! Photos and figures are for illustration onla. Colour and design ist not guaranteed.
Gabelflansch DIN 250/8-18 / L1=108 für KR 72x185	flange yoke DIN 250/8-18 / L1=108 for UJ 72x185	



Gewicht: 12,600 kg

D1	250,00	L1	108,00	A	6,00	W	24°
D2	218,00			B	18,00		
D3	18,00						
D4	140,00						
D6	72,00						