

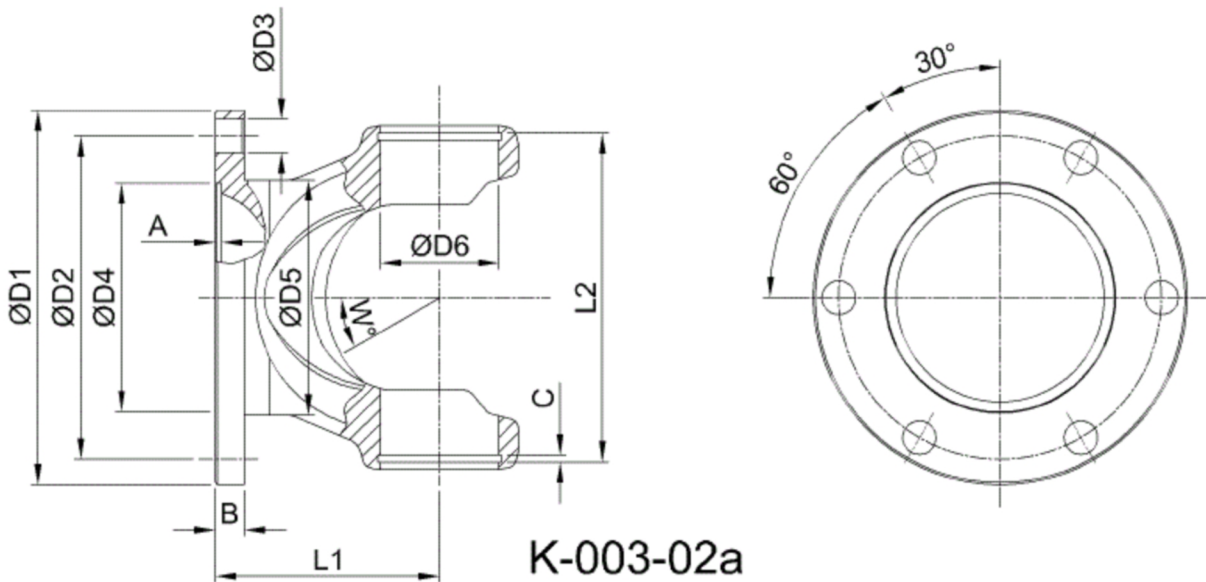

Artikelnummer identification code	<b>0030006</b>	Fotos und Bilder dienen nur der Veranschaulichung. Abweichungen in Farbe und Form sind möglich! Photos and figures are for illustration onla. Colour and design ist not guaranteed.
Gabelflansch DIN 75/6-6 / L1=36		flange yoke DIN 75/6-6 / L1=36
für KR 22x58		for UJ 22x58

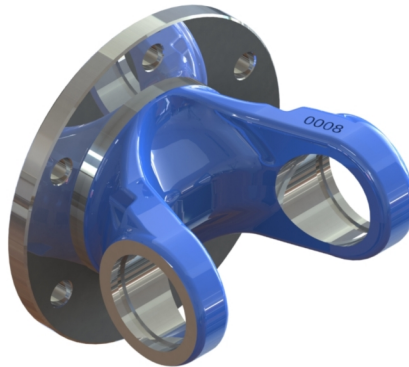

Gewicht: 0,300 kg

D1	75,00	L1	36,00	A	2,00	W	25°
D2	62,00	L2	60,00	B	5,50		
D3	6,00			C	2,00		
D4	42,00						
D5	45,00						
D6	22,00						