

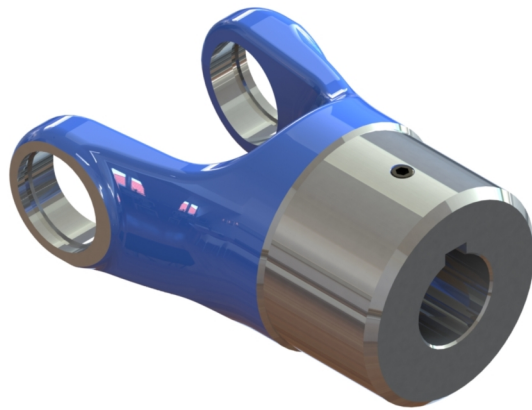

Artikelnummer identification code	0750259	Fotos und Bilder dienen nur der Veranschaulichung. Abweichungen in Farbe und Form sind möglich! Photos and figures are for illustration onla. Colour and design ist not guaranteed.
Nabengabel 20H7/6P9 / L1=50		sleeve yoke 20H7/6P9 / L1=50
für KR 17x41		for UJ 17x41

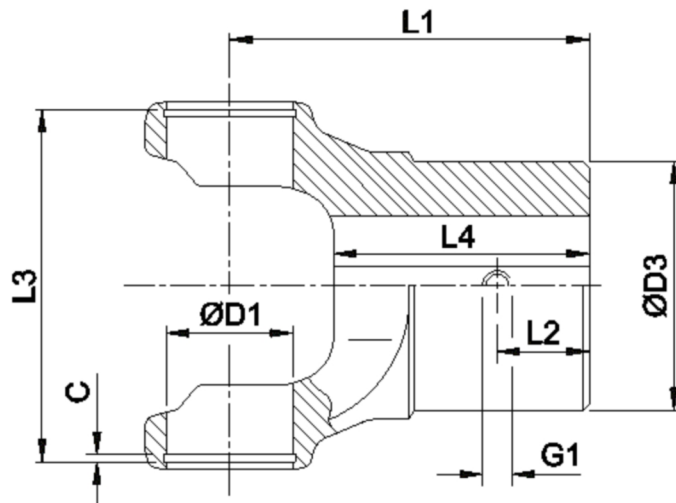

K-075-01b

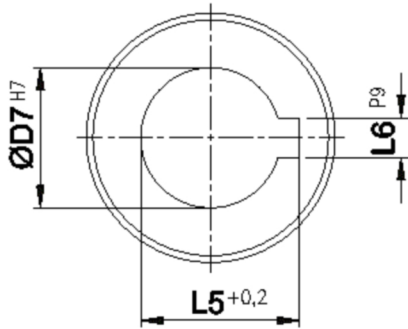

Gewicht: 0,250 kg

D1	17,00	L1	50,00	C	2,00	W	30°
D3	38,00	L2	10,00	G1	M5		
D4	52,00	L3	43,00				
D7	20,00	L4	26,00				
		L5	22,80				
		L6	6,00				