

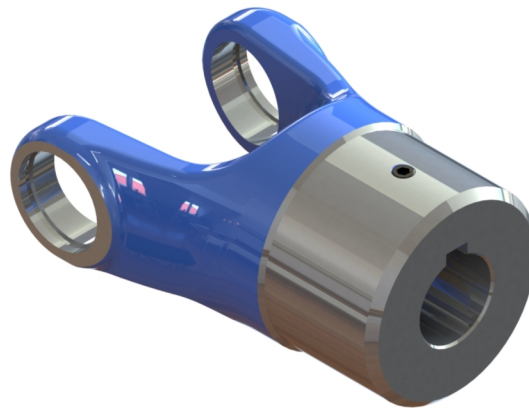

Artikelnummer identification code	0750174	Fotos und Bilder dienen nur der Veranschaulichung. Abweichungen in Farbe und Form sind möglich! Photos and figures are for illustration onla. Colour and design ist not guaranteed.
Nabengabel 15H7/5P9 / L1=72		sleeve yoke 15H7/5P9 / L1=72
für KR 20x47,2 (M6)		for UJ 20x47,2 (M6)

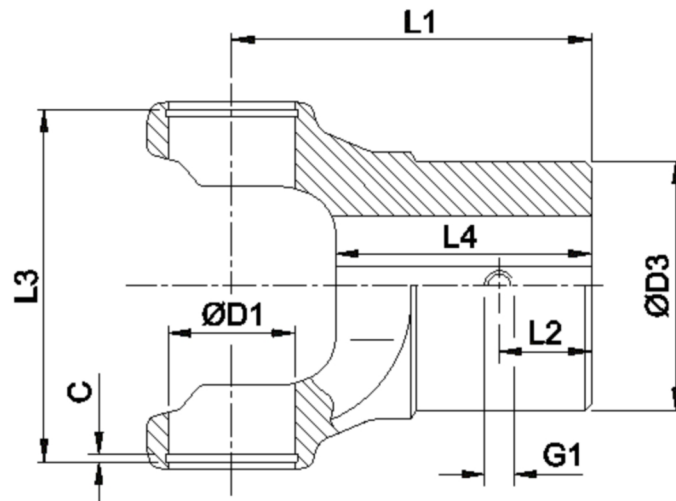

K-075-01b

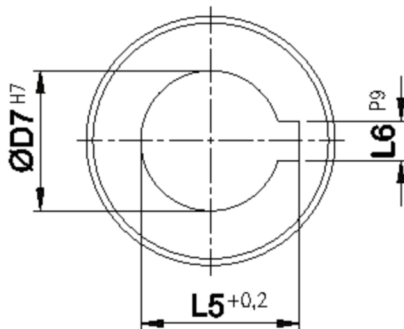

Gewicht: 0,625 kg

D1	20,00	L1	72,00	C	2,00	W	35°
D3	48,00	L2	10,00	G1	M4		
D7	15,00	L3	49,00				
		L4	37,00				
		L5	17,30				
		L6	5,00				