

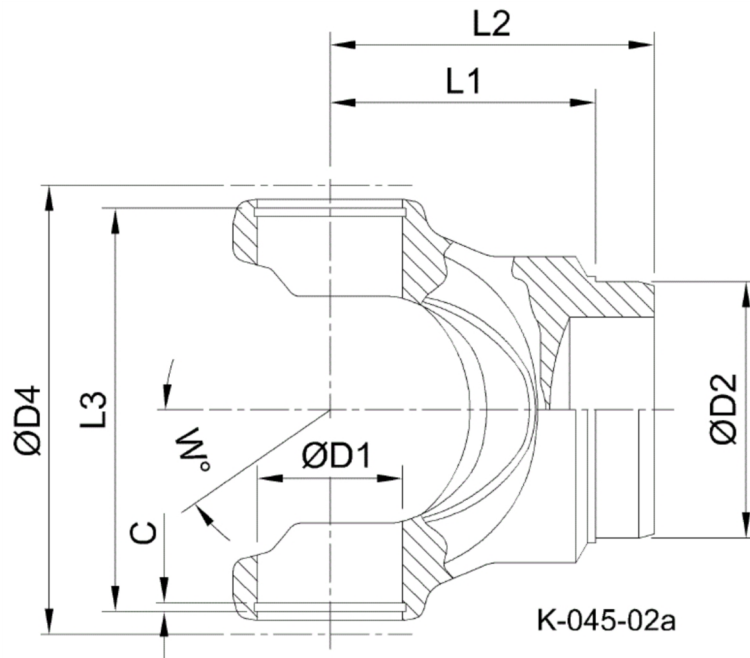

Artikelnummer identification code	0450169	Fotos und Bilder dienen nur der Veranschaulichung. Abweichungen in Farbe und Form sind möglich! Photos and figures are for illustration onla. Colour and design ist not guaranteed.
Schweisszapfen RA=54,3 / L1=48		tube yoke tc=54,3 / L1=48
für KR 30x81,8		for UJ 30x81,8



Gewicht: 0,800 kg

D1	30,00	L1	48,00	W	35°
D2	54,30	L3	85,10		