

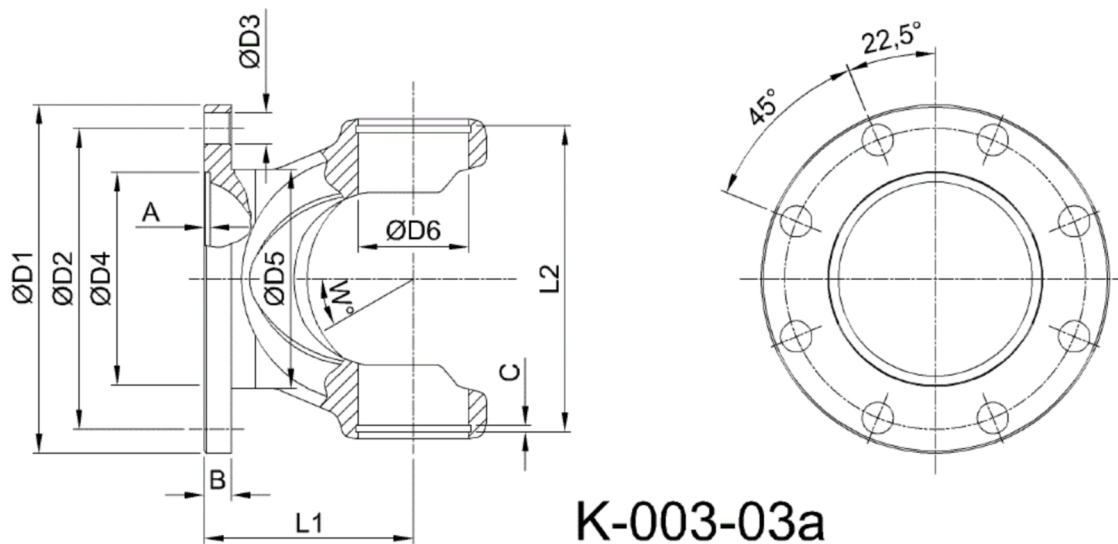

Artikelnummer identification code	<h1>0030453-3</h1>	Fotos und Bilder dienen nur der Veranschaulichung. Abweichungen in Farbe und Form sind möglich! Photos and figures are for illustration onla. Colour and design ist not guaranteed.
Gabelflansch DIN 150/8-12 / L1=72	flange yoke DIN 150/8-12 / L1=72	
für KR 42x119,4	for UJ 42x119,4	



K-003-03a

Gewicht: 2,600 kg

D1	150,00	L1	72,00	A	3,00	W	20°
D2	130,00	L2	122,60	B	10,00		
D3	12,00			C	2,70		
D4	90,00						
D5	100,00						
D6	42,00						