

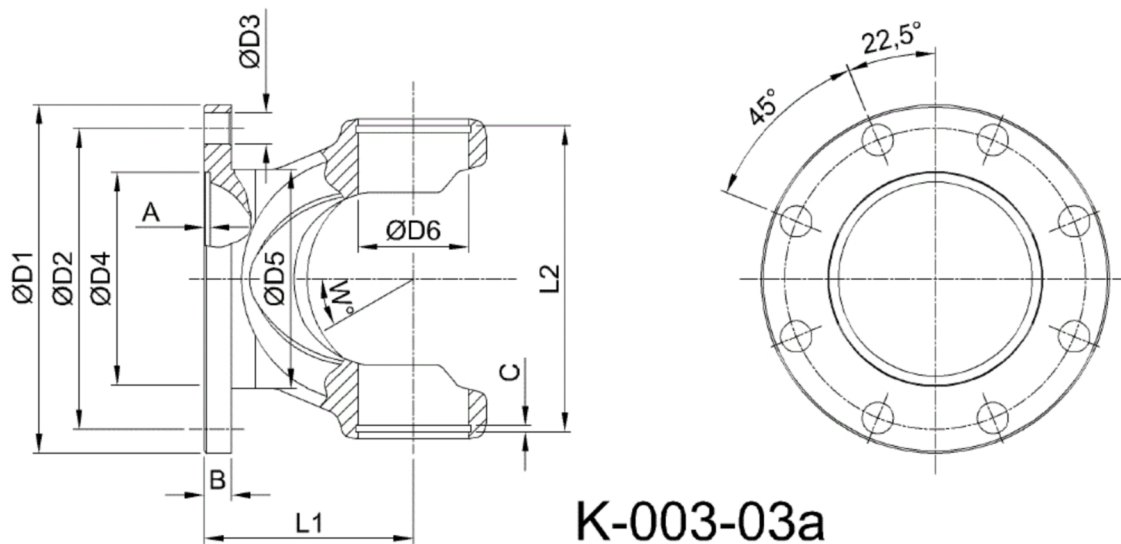

Artikelnummer identification code	<h1>0030409</h1>	Fotos und Bilder dienen nur der Veranschaulichung. Abweichungen in Farbe und Form sind möglich! Photos and figures are for illustration onla. Colour and design ist not guaranteed.
Gabelflansch DIN 150/8-12 / L1=95 für KR 47,6x135,1	flange yoke DIN 150/8-12 / L1=93 for UJ 47,6x135,1	



K-003-03a

Gewicht: 3,700 kg

D1	150,00	L1	95,00	A	3,00	W	35°
D2	130,00	L2	138,39	B	10,00		
D3	12,00			C	3,00		
D4	90,00						
D5	100,00						
D6	47,64						