

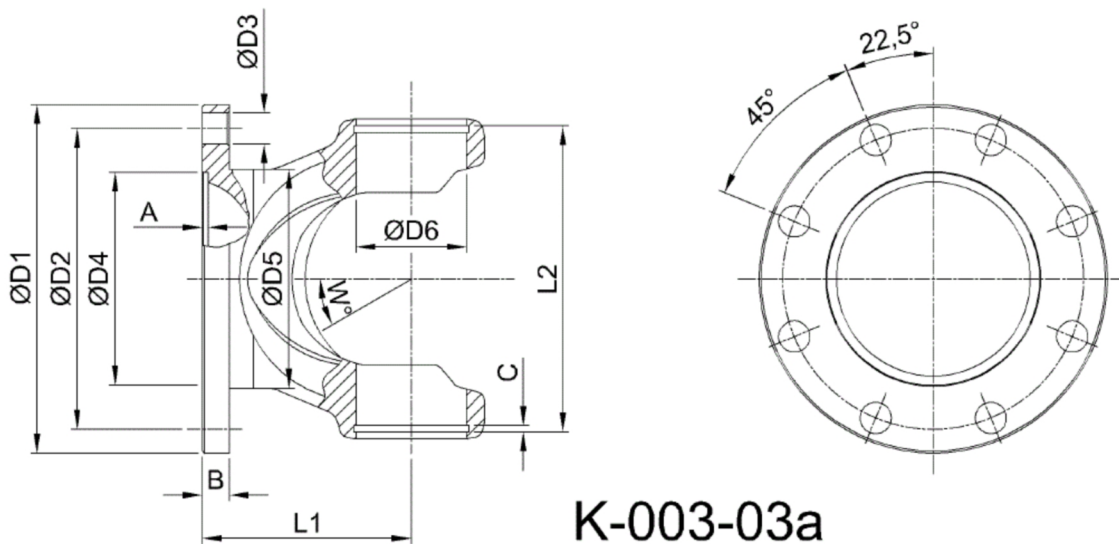

Artikelnummer identification code	<h1>0030142-3</h1>	Fotos und Bilder dienen nur der Veranschaulichung. Abweichungen in Farbe und Form sind möglich!  Photos and figures are for illustration onla. Colour and design ist not guaranteed.
Gabelflansch DIN 120/8-10 / L1=75		flange yoke DIN 120/8-10 / L1=75
für KR 42x104,5		for UJ 42x104,5



K-003-03a

Gewicht: 1,900 kg

D1	120,00	L1	75,00	A	3,00	W	35°
D2	101,50	L2	107,70	B	8,00		
D3	10,00			C	2,15		
D4	75,00						
D5	80,00						
D6	42,00						