

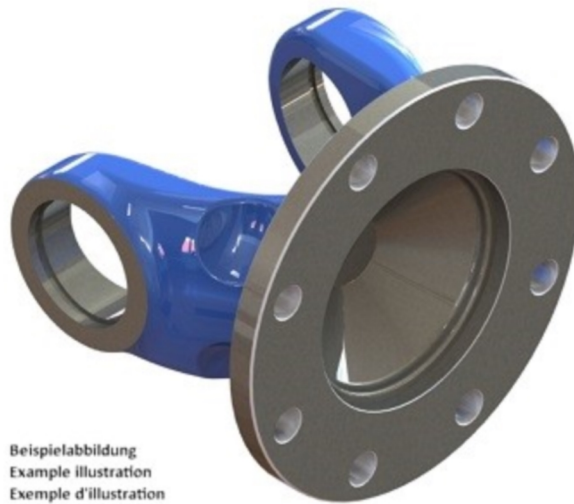

Artikelnummer identification code	0030033-1	Fotos und Bilder dienen nur der Veranschaulichung. Abweichungen in Farbe und Form sind möglich! Photos and figures are for illustration onla. Colour and design ist not guaranteed.
Gabelflansch DIN 150/8-12 / L1=65		flange yoke DIN 150/8-12 / L1=65
für KR 42x117,5		for UJ 42x117,5

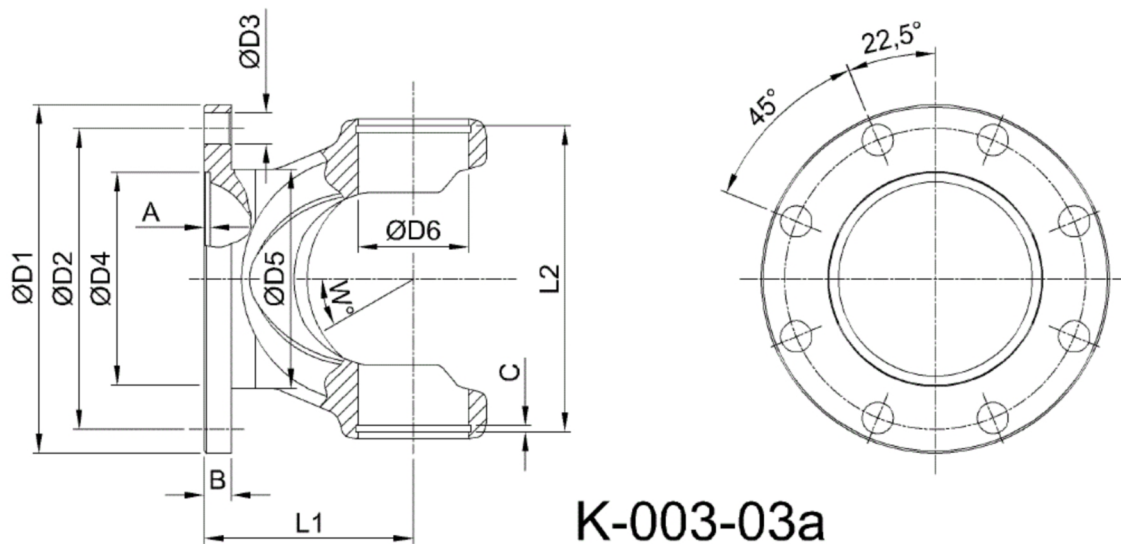

Beispielabbildung
Example illustration
Exemple d'illustration
Ilustración de ejemplo
Пример иллюстрации



K-003-03a

Gewicht: 2,410 kg

D1	150,00	L1	65,00	A	3,00	W	20°
D2	130,00			B	10,00		
D3	12,00						
D4	90,00						
D6	42,00						